

EOS StainlessSteel 316L
Material Data Sheet

EOS StainlessSteel 316L

EOS StainlessSteel 316L is a high performance marine-grade austenitic stainless steel that is molybdenum alloyed for enhanced corrosion resistance in chloride environments. 316L is a standard material for numerous applications in process, energy, paper, transportation and other industries. EOS StainlessSteel 316L is a stainless steel powder intended for manufacturing parts on EOS metal systems with EOS DMLS processes.

Main Characteristics:

- High ductility and toughness
- High strength
- High corrosion resistance

Typical Applications:

- Chemical industry
- Food processing
- Medical devices

The EOS Quality Triangle

EOS uses an approach that is unique in the AM industry, taking each of the three central technical elements of the production process into account: the system, the material and the process – together simply described as the Quality Triangle. EOS focuses on delivering reproducible part properties for the customer.

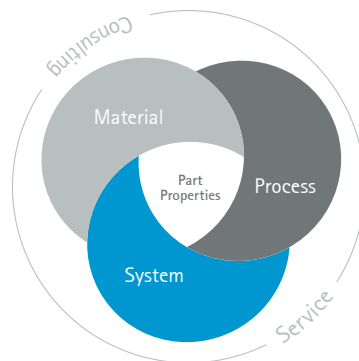

All of the data stated in this material data sheet is produced according to EOS Quality Management System and international standards.

Powder Properties

The chemical composition of EOS StainlessSteel 316L corresponds to ASTM F138 material standard for Surgical Implants (UNS S31673).

Powder chemical composition (wt.-%)

Element	Min.	Max.
Fe	Balance	
Cr	17.00	19.00
Ni	13.00	15.00
Mo	2.25	3.00
C	-	0.03
N	-	0.10

Powder particle size

Generic particle size distribution

20 – 65 μm

SEM picture of EOS StainlessSteel 316L powder.

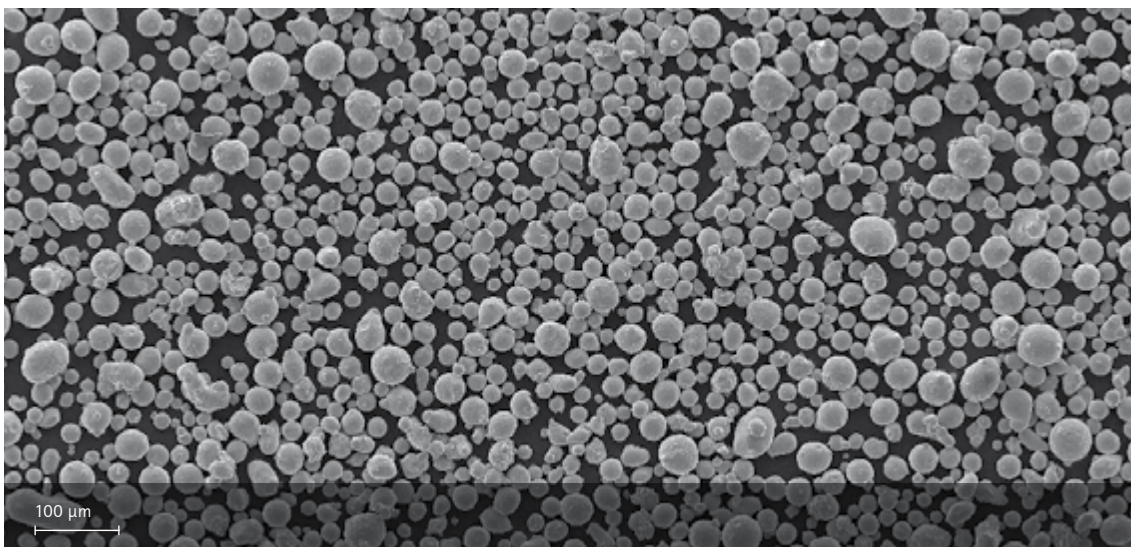

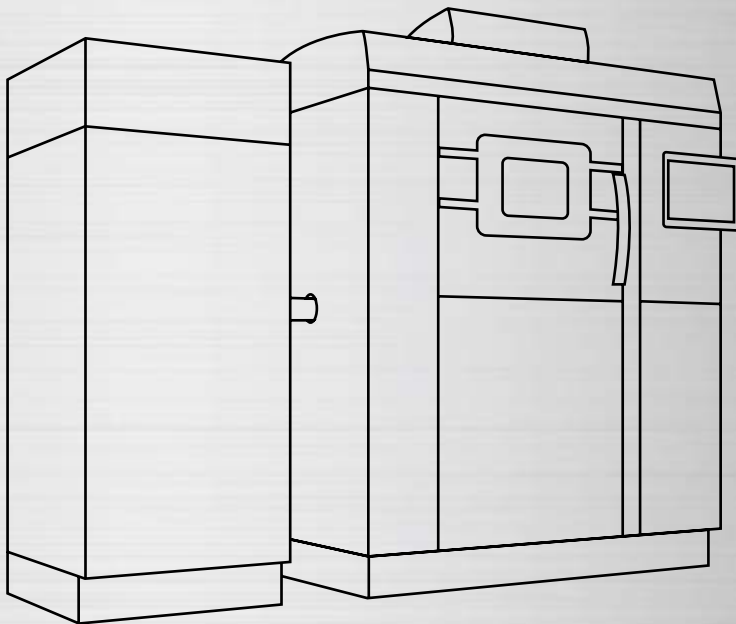

EOS StainlessSteel 316L for EOS M 290 | 20 μm

Process Information

Chemical and Physical Part Properties

Heat Treatment

Mechanical Properties

Additional Data

EOS StainlessSteel 316L for EOS M 290 | 20 µm

Process Information

This process product is optimized for robustly building parts with EOS M 290 system using EOS StainlessSteel 316L. The mechanical properties have been validated to TRL8 level.

System set-up	EOS M 290
EOS ParameterSet	316L 20µm Surface M290/400W
EOSPAR name	316L_Surface_1.X
Software requirements	EOSPRINT 2.7 or newer EOSYSTEM 2.11 or newer
Powder part no.	9011-0032
Recoater blade	EOS HSS blade
Nozzle	Standard nozzle
Inert gas	Argon
Sieve	63 µm

Additional information

Layer thickness	20 µm
Min. wall thickness	0.3 - 0.4 mm
Typical dimensional change after HT	+0.02 %
Volume rate	2.0 mm ³ /s

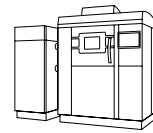

Chemical and Physical Properties of Parts¹

Chemical composition of built parts is compliant to EOS StainlessSteel 316L powder chemical composition.

Micrograph of polished surface

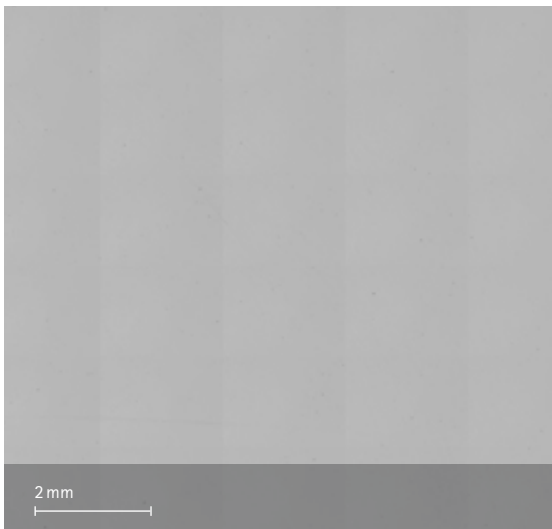

Microstructure solution annealed
Etched with etchant Kallings 2



Defects	Result	Number of samples
Average defect percentage	0.018 %	45
Density, ISO3369	Result	Number of samples
Average density	≥ 7.97 g/cm ³	45

Heat Treatment

Heat treatment according to AMS 2759 is optional.

Stress relief: Hold temperature 900 °C, hold time minimum 2 h when thoroughly heated, water quenching

Solution annealing: Hold temperature 1 150 °C, hold time minimum 1.5 h when thoroughly heated, water quenching

Mechanical Properties as Manufactured¹

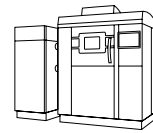

Mechanical properties ISO6892-1

	Yield strength $R_{p0.2}$ [MPa]	Tensile strength R_m [MPa]	Elongation at break A [%]	Number of samples
Vertical	470	540	54	189
Horizontal	530	640	40	162

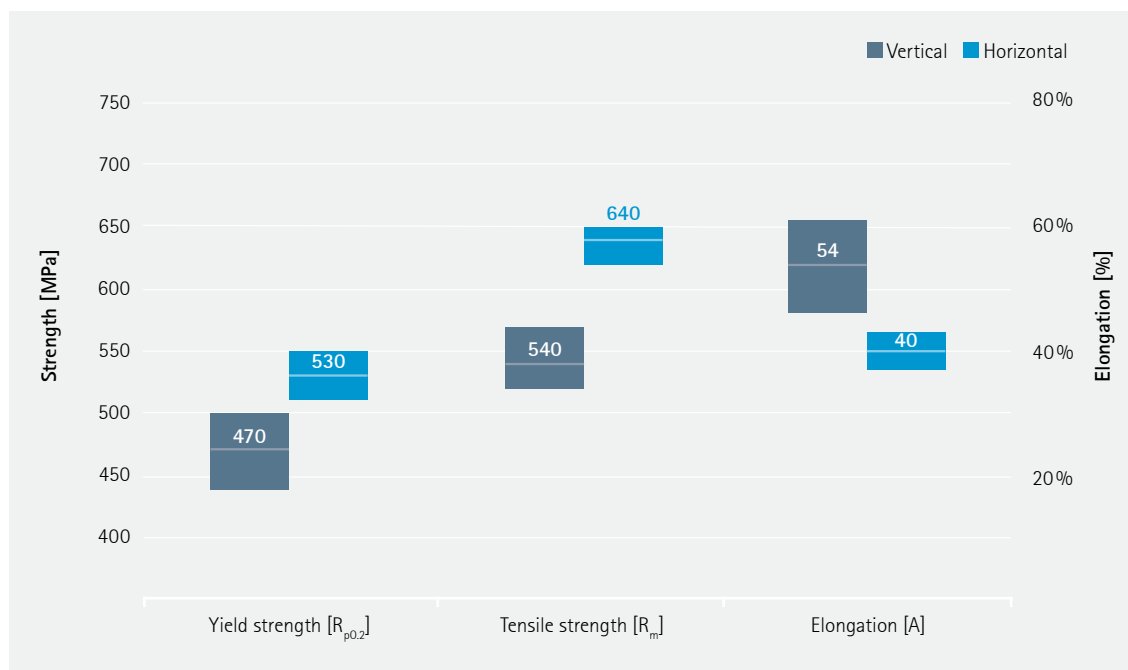

Additional Data¹

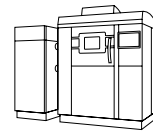

Surface Roughness

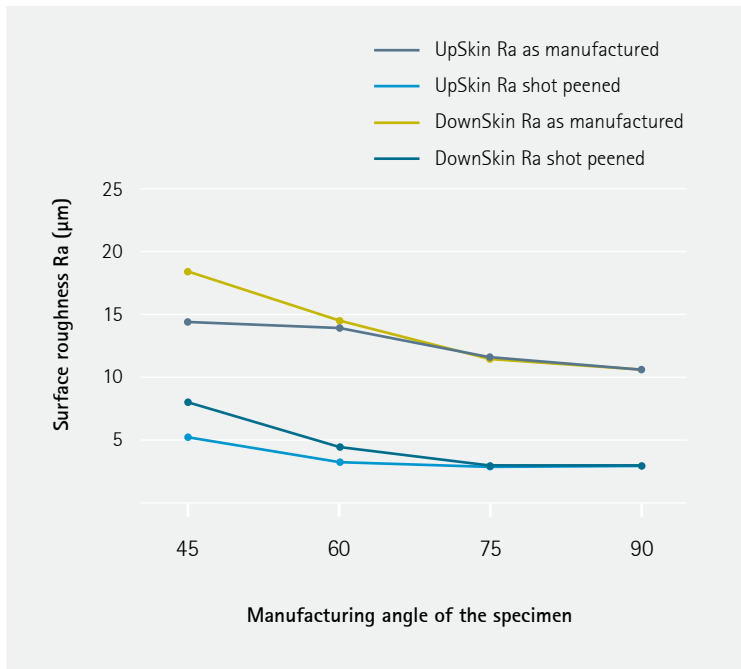

Coefficient of Thermal Expansion ASTM E228

Temperature	25-100 °C	25-200 °C	25-300 °C	25-400 °C
CTE	15.72 *10 ⁻⁶ /K	16.75 *10 ⁻⁶ /K	17.27 *10 ⁻⁶ /K	17.70 *10 ⁻⁶ /K

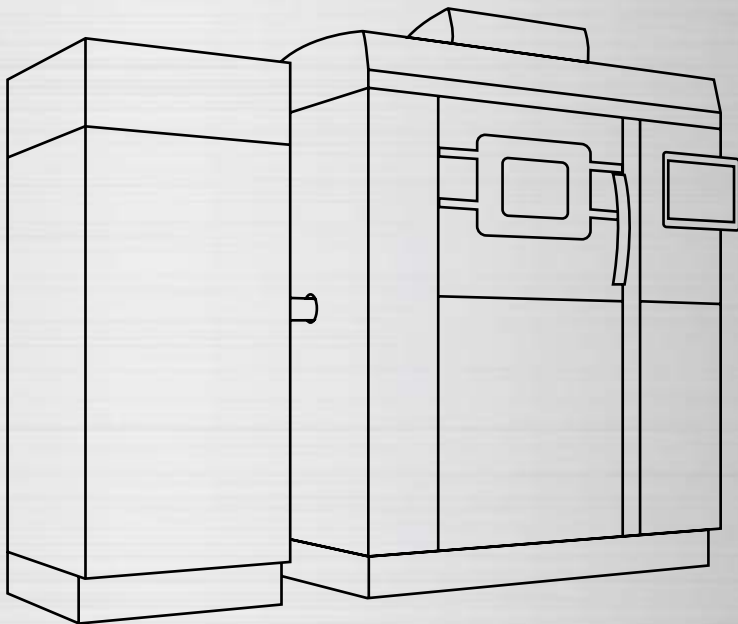

EOS StainlessSteel 316L for EOS M 290 | 40 μm

Process Information

Chemical and Physical Part Properties

Heat Treatment

Mechanical Properties

Additional Data

EOS StainlessSteel 316L for EOS M 290 | 40 µm

Process Information

This process product is optimized for building high quality parts with EOS M 290 system reliably using EOS StainlessSteel 316L. Mechanical properties have been validated to TRL7 level.

System set-up	EOS M 290
EOS ParameterSet	316L 40µm FlexLine
EOSPAR name	316L_040_FlexM291_1.X
Software requirements	EOSPRINT 2.7 or newer EOSYSTEM 2.11 or newer
Powder part no.	9011-0032
Recoater blade	EOS HSS blade
Nozzle	EOS grid nozzle
Inert gas	Argon
Sieve	63 µm

Additional information

Layer thickness	40 µm
Min. wall thickness	0.1 mm
Typical dimensional change after HT	+0.2 %
Volume rate	3.7 mm ³ /s

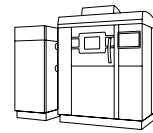

Chemical and Physical Properties of Parts¹

Chemical composition of built parts is compliant to EOS StainlessSteel 316L powder chemical composition.

Micrograph of polished surface

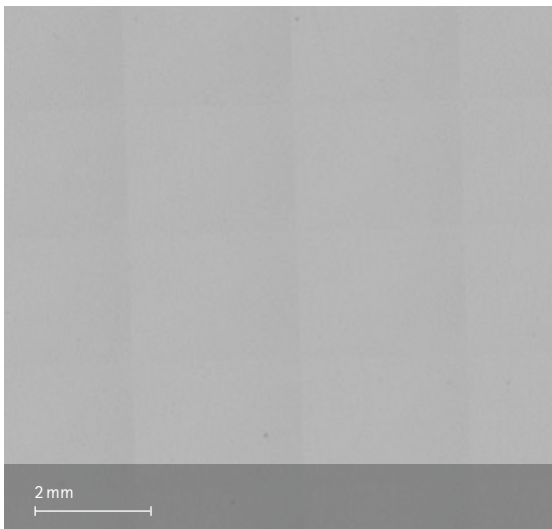

Microstructure solution annealed
Etched with etchant Kallings 2



Defects	Result	Number of samples
Average defect percentage	0.015 %	20
Density, ISO3369	Result	Number of samples
Average density	≥ 7.97 g/cm ³	20

Heat Treatment

Heat treatment according to AMS 2759 is optional.

Stress relief: Hold temperature 900 °C, hold time minimum 2 h when thoroughly heated, water quenching

Solution annealing: Hold temperature 1 150 °C, hold time minimum 1.5 h when thoroughly heated, water quenching

Mechanical Properties as Manufactured¹

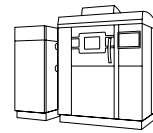

Mechanical properties ISO6892-1

	Yield strength $R_{p0.2}$ [MPa]	Tensile strength R_m [MPa]	Elongation at break A [%]	Number of samples
Vertical	480	570	51	105
Horizontal	540	640	40	90



Additional Data¹

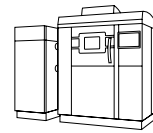

Surface Roughness

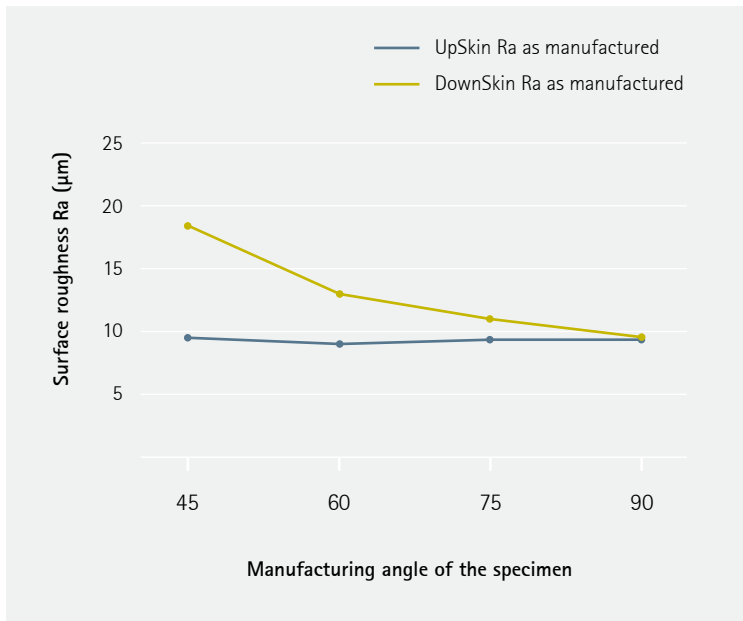

Coefficient of Thermal Expansion ASTM E228

Temperature	25-100 °C	25-200 °C	25-300 °C	25-400 °C
CTE	15.72 *10 ⁻⁶ /K	16.75 *10 ⁻⁶ /K	17.27 *10 ⁻⁶ /K	17.70 *10 ⁻⁶ /K

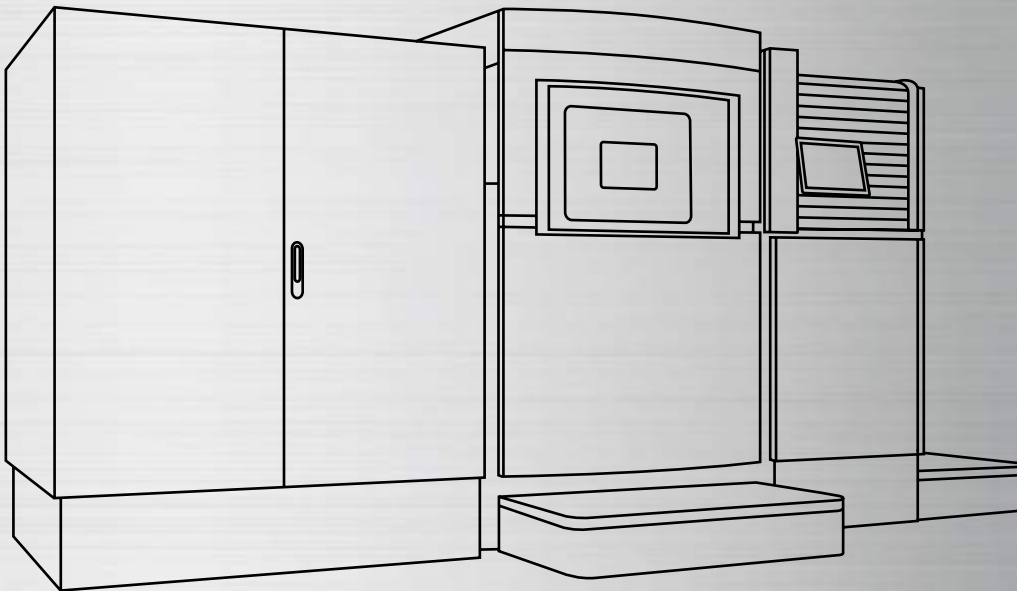

EOS StainlessSteel 316L for EOS M 400-4 | 40 μm

Process Information
Chemical and Physical Part Properties
Heat Treatment
Mechanical Properties
Additional Data

EOS StainlessSteel 316L for EOS M 400-4 | 40 µm

Process Information

This process product is optimized for building high quality parts with EOS M 400-4 system using EOS StainlessSteel 316L.

System set-up	EOS M 400-4
EOS ParameterSet	316L 40µm Flex M 400-4
EOSPAR name	316L_040_FlexM404_1.X
Software requirements	EOSPRINT 2.7 or newer EOSYSTEM 2.11 or newer
Powder part no.	9011-0032
Recoater blade	EOS HSS blade
Inert gas	Argon
Sieve	63 µm

Additional information

Layer thickness	40 µm
Volume rate	14.8 mm ³ /s

Chemical and Physical Properties of Parts¹

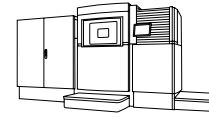

Chemical composition of built parts is compliant to EOS StainlessSteel 316L powder chemical composition.

Micrograph of polished surface

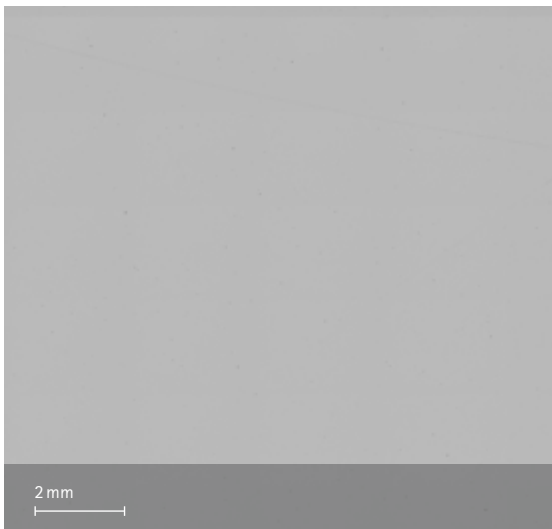

Microstructure solution annealed
Etched with etchant Kallings 2



Defects	Result	Number of samples
Average defect percentage	0.015 %	40

Density, ISO3369	Result	Number of samples
Average density	≥ 7.9 g/cm ³	40

Heat Treatment

Heat treatment according to AMS 2759 is optional.

Stress relief: Hold temperature 900 °C, hold time minimum 2 h when thoroughly heated, water quenching

Solution annealing: Hold temperature 1 150 °C, hold time minimum 1.5 h when thoroughly heated, water quenching

Mechanical Properties as Manufactured¹

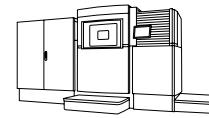

Mechanical properties ISO6892-1

	Yield strength $R_{p0.2}$ [MPa]	Tensile strength R_m [MPa]	Elongation at break A [%]	Number of samples
Vertical	490	590	45	120
Horizontal	550	650	40	96



Additional Data¹

Coefficient of Thermal Expansion ASTM E228

Temperature	25-100 °C	25-200 °C	25-300 °C	25-400 °C
CTE	$15.72 \cdot 10^{-6}/K$	$16.75 \cdot 10^{-6}/K$	$17.27 \cdot 10^{-6}/K$	$17.70 \cdot 10^{-6}/K$

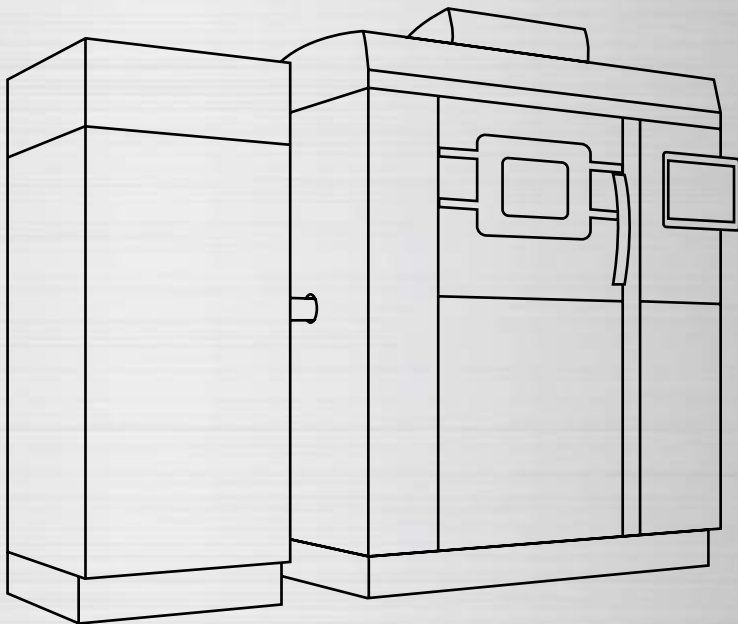

EOS StainlessSteel 316L for EOS M 290 | 40/80 μm

Process Information

Chemical and Physical Part Properties

Heat Treatment

Mechanical Properties

Additional Data

EOS StainlessSteel 316L for EOS M 290 | 40/80 µm

Process Information

This process product is optimized for flexible and fast production of EOS StainlessSteel 316L parts with the EOS M 290 system. The parameter set has three different layer thickness options that can all be utilized within the same build: 40 µm, 80 µm and 40/80 µm Skin.

The 40 µm parameter set is ideal for parts needing great detail resolution and more dense structure. The 80 µm parameter set offers a build rate that is more than double that of the long established 40 µm parameter set.

With the 40/80 µm Skin parameter set, the total build time can be reduced with the same surface quality. The parameter sets are assigned to different sections in the same build job depending on the requirements.

Main characteristics:

- Parameter set for fast and cost efficient production of EOS StainlessSteel 316L parts in small series or serial production
- With 80 µm parameter 100 % increase in productivity compared to the 40 µm FlexLine parameter set
- Faster production without compromising the part quality

System set-up	EOS M 290
EOS ParameterSet	316L 40µm+80µm Core M290/400W
EOSPAR name	316L_040_080_Core M291 1.X
Software requirements	EOSPRINT 2.7 or newer EOSYSTEM 2.11 or newer
Powder part no.	9011-0032
Recoater blade	EOS HSS blade
Nozzle	EOS grid nozzle
Inert gas	Argon
Sieve	63 µm

Additional information

Layer thickness	40 µm, 80 µm & 40/80 µm Skin
Volume rate*	3.7 mm ³ /s (40 µm), 8.4 mm ³ /s (80 µm), 3.7 - 8.4 (40/80 µm Skin)

* Volume rate depends on the part dimensions and skin thickness.

Chemical and Physical Properties of Parts¹

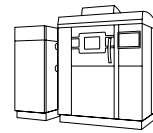

Chemical composition of built parts is compliant to EOS StainlessSteel 316L powder chemical composition.

Micrograph of polished surface (40 μm)



Micrograph of polished surface (80 μm)

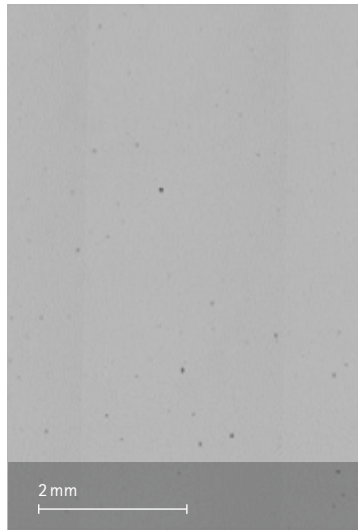

Microstructure solution annealed Etched with etchant Kallings 2



Defects	Result
Average defect percentage	0.1 %* (40 μm), < 0.2 %* (80 μm)

* Defect% varies with platform position.

Heat Treatment

Heat treatment according to AMS 2759 is optional.

Stress relief: Hold temperature 900 °C, hold time minimum 2 h when thoroughly heated, water quenching

Solution annealing: Hold temperature 1 150 °C, hold time minimum 1.5 h when thoroughly heated, water quenching

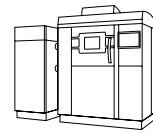

Mechanical Properties as Manufactured¹

Typical properties as manufactured ISO 6892-1

	Yield strength $R_{p0.2}$ [MPa]	Tensile strength R_m [MPa]	Elongation at break A [%]
40 μm horizontal	500	600	35
40 μm vertical	450	550	50
80 μm horizontal	500	600	35
80 μm vertical	450	550	45

Additional Data¹

Surface Roughness

Surface roughness	9 - 15 Ra
Surface roughness shot-peened	<5 Ra

Coefficient of Thermal Expansion ASTM E228

Temperature	25-100 °C	25-200 °C	25-300 °C	25-400 °C
CTE	$15.72 \cdot 10^{-6}/\text{K}$	$16.75 \cdot 10^{-6}/\text{K}$	$17.27 \cdot 10^{-6}/\text{K}$	$17.70 \cdot 10^{-6}/\text{K}$

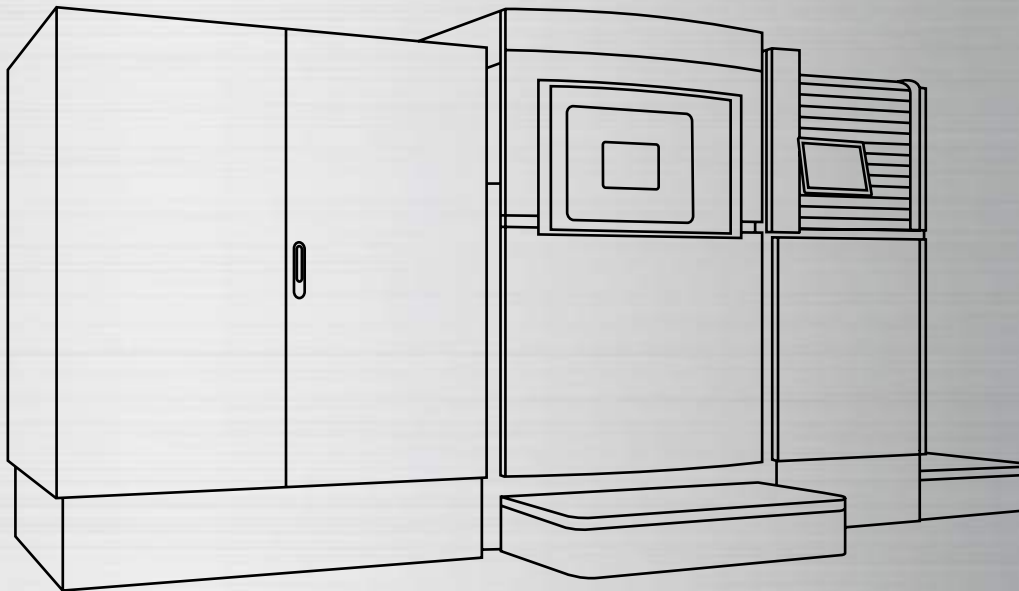

EOS StainlessSteel 316L for EOS M 400-4 | 40/80 μm

Process Information

Chemical and Physical Part Properties

Heat Treatment

Mechanical Properties

Additional Data

EOS StainlessSteel 316L for EOS M 400-4 | 40/80 µm Process Information

This process product is optimized for flexible and fast production of EOS StainlessSteel 316L parts with the EOS M 400-4 system. The parameter set has three different layer thickness options that can all be utilized within the same build: 40 µm, 80 µm and 40/80 µm Skin.

The 40 µm parameter set is ideal for parts needing great detail resolution and more dense structure. The 80 µm parameter set offers a build rate that is more than double that of the long established 40 µm parameter set.

With the 40/80 µm Skin parameter set, the total build time can be reduced with the same surface quality. The parameter sets are assigned to different sections in the same build job depending on the requirements.

Main Characteristics:

- Parameter set for fast and cost efficient production of EOS StainlessSteel 316L parts in small series or serial production
- With 80 µm parameter 100 % increase in productivity compared to the 40 µm FlexLine parameter set
- Faster production without compromising the part quality

System set-up	EOS M 400-4
EOS ParameterSet	316L 40µm+80µm Core M400-4
EOSPAR name	316L_040_080_Core M404 1.X
Software requirements	EOSPRINT 2.7 or newer EOSYSTEM 2.11 or newer
Powder part no.	9011-0032
Recoater blade	EOS HSS blade
Inert gas	Argon
Sieve	63 µm

Additional information

Layer thickness	40 µm, 80 µm & 40/80 µm Skin
Volume rate*	14.8 mm ³ /s (40µm), 33.6 mm ³ /s (80µm) and 14.8 – 33.6 mm ³ /s (40/80 µm Skin)

* Volume rate depends on the part dimensions and skin thickness.

Chemical and Physical Properties of Parts¹

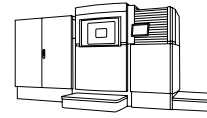

Chemical composition of built parts is compliant to EOS StainlessSteel 316L powder chemical composition.

Micrograph of polished surface (40 μm)

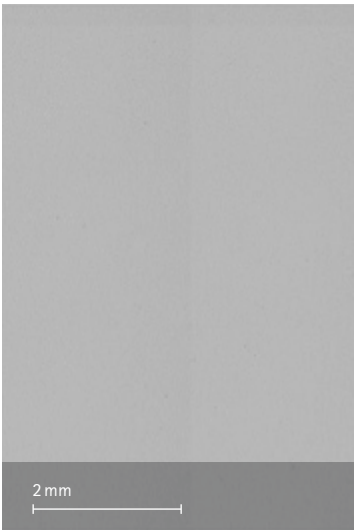

Micrograph of polished surface (80 μm)

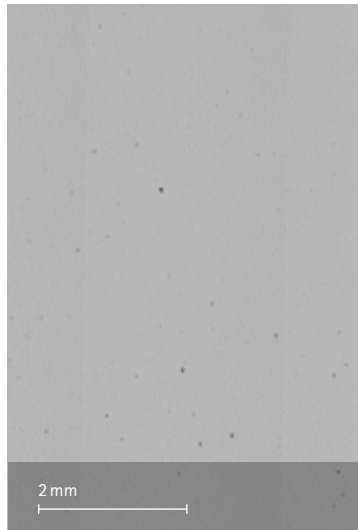

Microstructure solution annealed Etched with etchant Kallings 2



Defects	Result
Average defect percentage	0.1 %* (40 μm), < 0.2 %* (80 μm)

* Defect% varies with platform position.

Heat Treatment

Heat treatment according to AMS 2759 is optional.

Stress relief: Hold temperature 900 °C, hold time minimum 2 h when thoroughly heated, water quenching

Solution annealing: Hold temperature 1 150 °C, hold time minimum 1.5 h when thoroughly heated, water quenching

Mechanical Properties as Manufactured¹

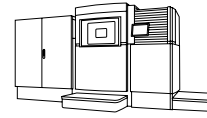

Typical properties as manufactured ISO 6892-1

	Yield strength $R_{p0.2}$ [MPa]	Tensile strength R_m [MPa]	Elongation at break A [%]
40 μm horizontal	500	600	35
40 μm vertical	450	550	50
80 μm horizontal	500	600	35
80 μm vertical	450	550	45

Additional Data¹

Surface Roughness

Surface roughness	9 - 15 Ra
Surface roughness shot-peened	<5 Ra

Coefficient of Thermal Expansion ASTM E228

Temperature	25-100 °C	25-200 °C	25-300 °C	25-400 °C
CTE	$15.72 \cdot 10^{-6}/\text{K}$	$16.75 \cdot 10^{-6}/\text{K}$	$17.27 \cdot 10^{-6}/\text{K}$	$17.70 \cdot 10^{-6}/\text{K}$

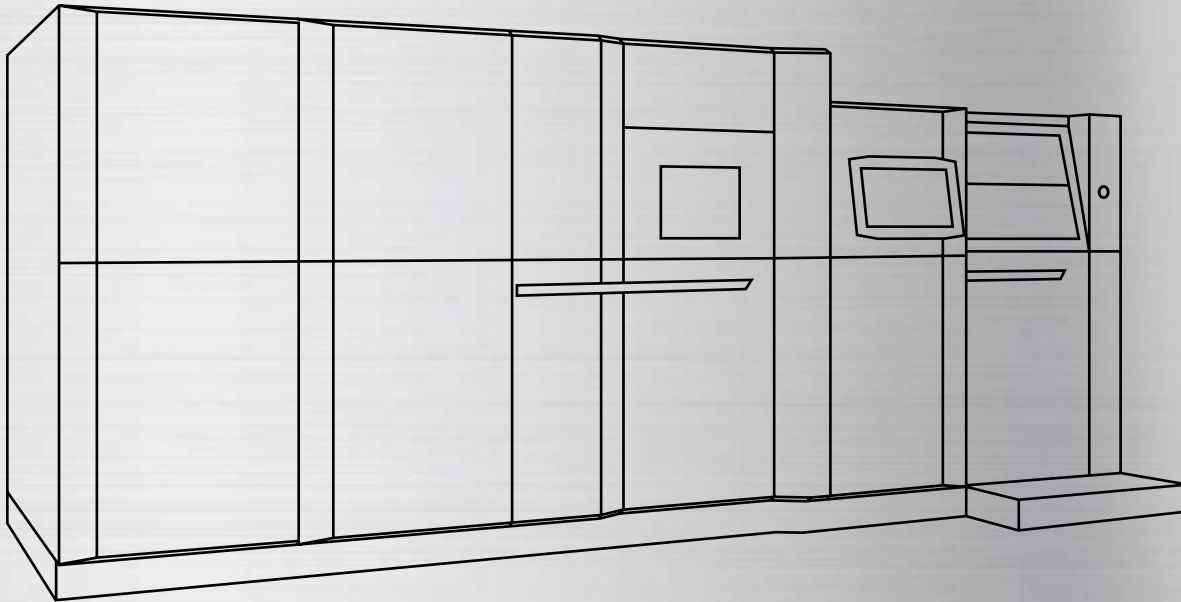

EOS StainlessSteel 316L for EOS M 300-4 | 40/80 μm

Process Information

Chemical and Physical Part Properties

Mechanical Properties

EOS StainlessSteel 316L for EOS M 300-4 | 40/80 µm Process Information

This process product is optimized for flexible and fast production of EOS StainlessSteel 316L parts with the EOS M 300-4 system. The parameter set has three different layer thickness options that can all be utilized within the same build: 40µm, 80 µm and 40/80 µm SkinCore.

For high productivity needs a 80 µm parameter set is included with a build rate more than double the 40µm parameter set. Both can be used separately for different parts or combined by using 40/80 µm SkinCore with faster 80 µm for the core of the part and higher quality 40 µm building for the surface of the part with defined thickness. Sectioning parts in the vertical direction for different parameters is also possible.

Main Characteristics:

- Parameter set for fast and cost efficient production of EOS StainlessSteel 316L parts in small series or serial production
- 100% increase in productivity with 80 µm parameter compared to 316L 40 µm FlexLine parameter with only minor decrease in quality
- High part quality – mechanical properties and surface – with 40 µm parameter

System set-up	EOS M 300-4
EOS ParameterSet	316L 40µm+80µm Core M300-4
EOSPAR name	316L_040_080_Core M304 1.X
Software requirements	EOSPRINT 2.11 or newer EOSYSTEM 2.15 or newer
Powder part no.	9011-0032
Recoater blade	EOS HSS blade
Inert gas	Argon
Sieve	63 µm

Additional information

Layer thickness	40 µm, 80 µm & 40/80 µm SkinCore
Volume rate*	14.8 mm ³ /s (40 µm), 33.6 mm ³ /s (80 µm) and 14.8 – 33.6 mm ³ /s (40/80 µm Skin)

* Volume rate depends on the part dimensions and skin thickness.

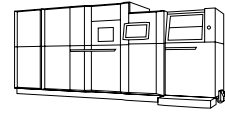

Chemical and Physical Properties of Parts¹

Defects	Result	Number of Samples
Average defect percentage 40 µm	0.002%	32
Average defect percentage 80 µm	0.024%	32
Max. pore size 40 µm	100 µm	32
Max. pore size 80 µm	150 µm	32

Mechanical Properties as Manufactured¹

Typical properties as manufactured ISO 6892-1

	Yield strength $R_{p0.2}$ [MPa]	Tensile strength R_m [MPa]	Elongation at break A [%]	Number of Samples
40 µm horizontal	575	671	34.3	64
40 µm vertical	510	607	41.3	160
80 µm horizontal	554	660	35.6	64
80 µm vertical	485	621	41.1	160

Layout of test job

Part properties based on two test jobs each for 40 µm and 80 µm process (as manufactured).

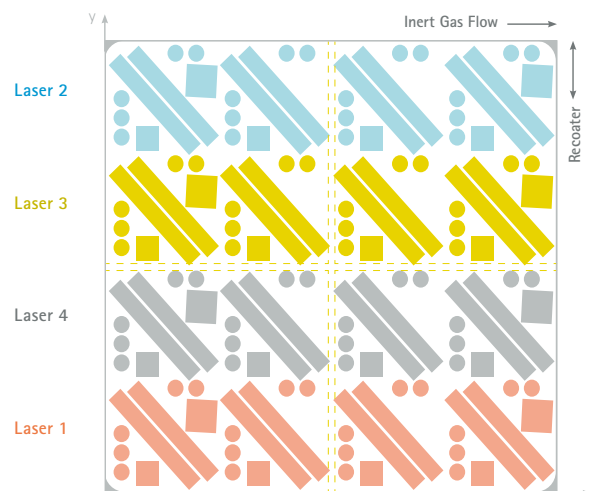

The values in the tables above are average values and dependent on the build platform temperature, the thermal load of the job layout as well as the position on the build plate.

Headquarters

EOS GmbH
Electro Optical Systems
Robert-Stirling-Ring 1
D-82152 Krailling/Munich
Germany
Phone +49 89 893 36-0
info@eos.info

www.eos.info

 EOS

 EOSGmbH

 EOSGmbH

#responsiblemanufacturing

#futureisadditive

Further Offices

EOS France
Phone +33 437 497 676

EOS Greater China
Phone +86 21 602 307 00

EOS India
Phone +91 443 964 8000

EOS Italy
Phone +39 023 340 1659

EOS Japan
Phone +81 45 670 0250

EOS Korea
Phone +82 2 6330 5800

EOS Nordic & Baltic
Phone +46 31 760 4640

EOS of North America
Phone +1 877 388 7916

EOS Singapore
Phone +65 6430 0463

EOS UK
Phone +44 1926 675 110

¹ Part properties are provided for information purposes only and EOS makes no representation or warranty, and disclaims any liability, with respect to actual part properties achieved. Part properties are dependent on a variety of influencing factors and therefore, actual part properties achieved by the user may deviate from the information stated herein.

This document does not on its own represent a sufficient basis for any part design, neither does it provide any agreement or guarantee about the specific properties of a material or part or the suitability of a material or a part for a specific application.

This powder has not been developed, tested or certified as a medical device according to Directive 93/42/EEC (MDD) or Regulation (EU) 2017/745 (MDR) and is not intended to be used as a medical device, in particular for the purposes specified in Art. 2 No. 1 MDR. Insofar as you intend to use the powder as raw material for the manufacture of pharmaceutical products or medical devices (e.g. as raw material which as a material must meet the requirements of Annex 1, Chapter II MDR), the responsibility and liability for all analyses, tests, evaluations, procedures, risk assessments, conformity assessments, approval and certification procedures as well as for all other official and regulatory measures required for this purpose shall lie solely with you both with regard to the pharmaceutical product and/or medical device manufactured by you and with regard to the properties, suitability, testing, evaluation, risk assessment, other requirements for use of the powder as raw material. This also applies to applications with food contact. In this respect, the limitations of liability pursuant to our General Terms and Conditions and the system sales or material contracts shall apply.

Status 07/2022

EOS is certified according to ISO 9001. EOS®, DMLS®, EOSPRINT® and EOSTATE® are registered trademarks of EOS GmbH Electro Optical Systems in some countries. For more information visit www.eos.info/trademarks.

Cover: This image shows a possible application.

